

A New Technique for PAPR Reduction in OFDM System

Ahmed K. Abed

Electrical & Electronic Department

College of Engineering

Thi-Qar University

Algenaby1975@yahoo.com

Abstract

Orthogonal frequency division multiplexing (OFDM) is an attractive technique for modern wireless communication. One major drawback of orthogonal frequency division multiplexing schemes is the high peak to average power ratio (PAPR) of the output signal. Selecting mapping (SLM) and partial transmit sequences (PTS) are two important techniques for reducing PAPR, but they need to transmit side information to indicate how the transmitter generates the signals. In this paper, we proposed an efficient technique to reduce PAPR in OFDM system. For this technique, circular shifter used to produce K cyclic sequences from the same information sequence. These sequences XOR with K randomly generated keys, the same keys used in receiver side to detect data. The sequence with the lowest PAPR among K sequences is chosen for transmission. Side Information (SI) is coded using Hamming code and embedded into the information sequence. Computer simulation tests have been applied on BPSK and $N=64$ subcarriers OFDM system with the proposed method. Moreover, this system will be evaluated under the effect of AWGN channel. The results exhibit the ability of such technique to reduce the PAPR without major effect on the system performance as compared with the conventional OFDM technique. The PAPR of OFDM signal is further reduced by 4–5 dB by this technique.

Keywords: Orthogonal Frequency Division Multiplexing OFDM, Peak to Average power ratio (PAPR), AWGN channel.

المستخلص

التجميع المتعدد بتقسيم التردد المتعامد OFDM تقنية فعالة للاتصالات اللاسلكية المتطورة . ارتفاع نسبة القمة إلى معدل القدرة واحدة من المشاكل الرئيسية في نظام OFDM . اختيار الأنماط الأنسب SLM و إرسال الجزء للنمط PTS تعتبر من أهم الطرق لتقليل PAPR ولكن مثل هذه الطرق تحتاج إلى إرسال معلومات إضافية مما يؤدي إلى تقليل كفاءة هذه الطريقتين. في هذا البحث اقترحت تقنية كفاءة لتقليل نسبة قمة إلى معدل قدرة الإشارة PAPR في نظام OFDM. في هذه التقنية استخدم المزرح الدائري circular shifter لتوليد K من الأنماط المزحفة بشكل دائري لنفس البيانات. هذه الأنماط تجمع مع K من المفاتيح عن

طريق بوابات XOR ، النمط الذي يرسل هو الذي يمتلك اقل نسبة أقصى إلى معدل قدرة الإشارة Minimum PAPR. المعلومات الإضافية SI لمقدار الإزاحة تشفر باستخدام Hamming code وتدمج مع نمط البيانات المرسل. تمت محاكاة النظام المقترح لمنظومة OFDM باستخدام الحاسوب حيث اعتمد عدد الحاملات $N=64$ وبتضمين Binary Phase Shift Keying (BPSK). اختبر النظام تحت تأثير ضوضاء الكاوسية للقناة AWGN channel. النتائج أظهرت قدرة النظام المقترح لتقليل PAPR بالمقارنة مع النظام التقليدي Conventional OFDM بحدود 4-5 ديسيبل.

1. Introduction

Orthogonal frequency division multiplexing (OFDM) is a promising technique for high speed data rate transmission [1]. Moreover, OFDM has also been widely applied to wideband communications over mobile radio channels, high-bit-rate digital subscriber lines (HDSL), and digital audio broadcasting (DAB), etc. However, one of the implementation drawbacks of OFDM is that the transmitted signal has a high peak to-average power ratio (PAPR). A communication system with high PAPR not only decreases the efficiency of a linear high power amplifier but also increases the complexity of an analog-to-digital converter. Therefore, the subject of finding a computationally efficient algorithm to decrease the PAPR in OFDM systems has become an active research.

Recently, many methods have been proposed to reduce the PAPR of the transmitted signal. Clipping is a simple effective technique for PAPR reduction by clipping the peak amplitude of amplification [2]. Since clipping is a nonlinear process, it may cause significant in-band distortion and out-of-band radiation. Several coding schemes that use a special forward error correcting code set that excludes OFDM signals with a large PAPR, thus they significantly reduce the rate of transmission for large values of N [3]. Selective mapping (SLM) [4] and partial transmit sequence (PTS) [5-6] are based on scrambling each OFDM signal with different scrambling sequences to obtain lower PAPR, and the sequence with the lowest PAPR is transmitted, both of which need to transmit side information (SI) to the receiver to recover the original sequence. In this paper, we proposed an efficient technique to reduce PAPR in OFDM system. The proposed technique depend on generating K pattern of same information sequence by using K circular shifters and K Keys scrambling by XOR gates. The identity of shifting circular registers sent as side information and embedded in data information. The performance of the proposed technique for reducing the PAPR is presented. This paper is organized as follow. Section 2 presents the definition of an OFDM system and the PAPR. Section 3 introduces the proposed system model. Results are presented in Section 4, and finally the paper concluded in Section 5.

2. OFDM system and paper definition

OFDM is a block modulation scheme where a block of information symbols is transmitted in parallel on sub-carriers. The time duration of an OFDM symbol is times larger than that of a single-carrier system. An OFDM modulator can be implemented as an inverse Fast Fourier transform (IFFT) on a block of information symbols followed by an analog-to-digital converter (ADC). Consider an OFDM system with N sub-carriers. Each OFDM block (OFDM symbol), $x(t)$, $0 \leq t \leq T$, consists of N complex baseband data X_0, X_1, \dots, X_{N-1} carried on the N subcarriers respectively for a symbol period of T . The OFDM symbol $x(t)$ is:

$$x(t) = \begin{cases} \frac{1}{\sqrt{N}} \sum_{n=0}^{N-1} X_n e^{j2\pi n \Delta f t} & 0 \leq t \leq T \\ 0 & \text{elsewhere} \end{cases} \quad (1)$$

Where $\Delta f = 1/T$ is the sub-carrier spacing and n denotes the index in frequency domain and X_n is the complex symbol in frequency domain. Furthermore, equation (1) can be expressed using the IFFT [7].

Figure (1) shows a typical block diagram of a Basic OFDM system. The serial input data stream is converted to N parallel sub channels and mapped with a selected modulation scheme, resulting in N subchannels containing the information in complex number form.

These complex values are then sent to the N channel IFFT. The parallel signals are converted back to a serial sequence by using a P/S converter. A guard interval is inserted to reduce the effect of ISI caused by multipath propagation. Finally, the signal is converted to analogue signal and converted back up to a suitable form for transmission. At the receiver, a reverse procedure is used to demodulate the OFDM signal.

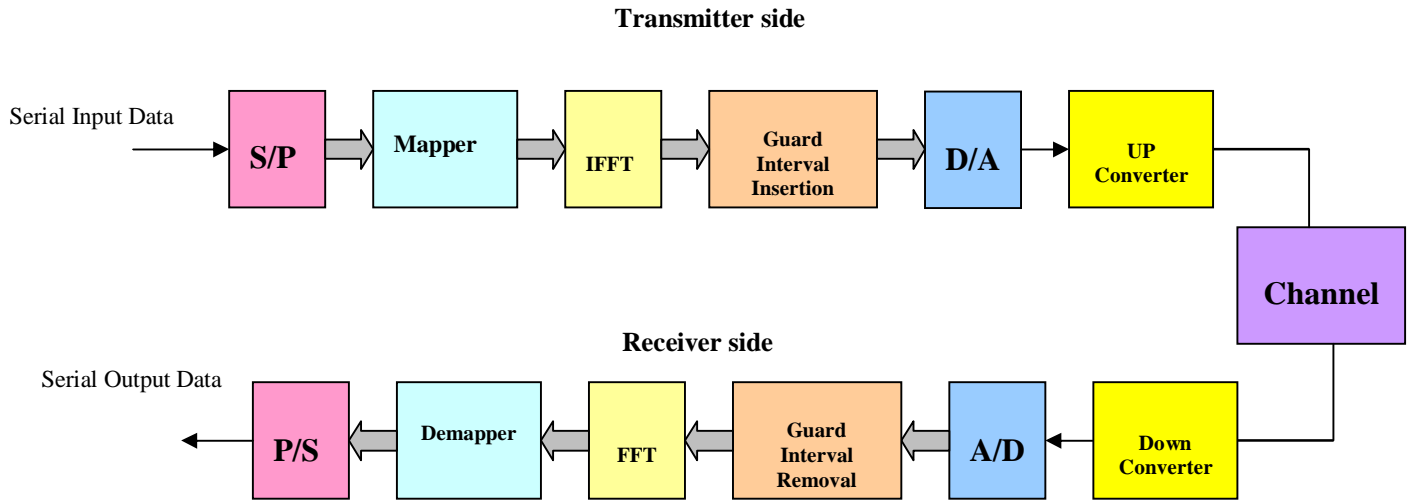

Figure (1). Block diagram of the basic OFDM system.

According to eq. (1), the peak instantaneous power is:

$$P_{\max} = \max_{t \in [0, T)} |x(t)|^2 \quad (2)$$

An OFDM symbol sequence can be represented by $x(t), x(t+T), \dots, x(t+mT), \dots$

The average power of OFDM symbol sequence is:

$$P_{\text{av}}(x_1, x_2, \dots, x_{n-1}) = \sum_{k=0}^{N-1} E[|x_k|^2] \quad (3)$$

Where $E[|x_k|^2]$ is the expected value of $|x_k|^2$. The peak average power ratio (PAPR) of the OFDM symbol $x(t)$ is:

$$\text{PAPR} = \frac{P_{\max}}{P_{\text{av}}(x_0, x_1, \dots, x_{n-1})} = \frac{\max_{t \in [0, T)} |x(t)|^2}{\sum_{k=0}^{N-1} E[|x_k|^2]} \quad (4)$$

If the power of the input signal is standard, the $E[|x_k|^2]$ equal to 1. Then:

$$\text{PAPR} = \max_{t \in [0, T)} |x(t)|^2 = \max_{t \in [0, T)} \left| \frac{1}{\sqrt{N}} \sum_{n=0}^{n-1} X_n e^{j2p\Delta ft} \right|^2 \leq N \quad (5)$$

As a result, the PAPR value is not larger than the number N of sub carriers, e.g. the peak power value of OFDM signals is N times larger than its average power. So, the maximum PAPR equals to N . With the increase in the number N of sub channels, the maximum PAPR increases linearly. This makes high demands on the linear range of the front-end amplifier in sending side.

Although the probability of the largest PAPR is low, in order to transfer these high PAPR of OFDM signal without distortion, all the linearity of the High Power Amplifier (HPA) in sending side, the front-end amplifier and A/D converter should meet the high requirement. But these equipments meeting the high requirement are expensive. Therefore, it is necessary and important to reduce PAPR in OFDM system.

For an OFDM signal with N subcarriers, the PAPR can be defined as [8]:

$$PAPR = \frac{\max|x(t)|^2}{E|x(t)|^2} \quad (6)$$

In particular, a base band OFDM signal with N sub channels has maximum PAPR equal to :

$$PAPR_{\max} = 10\log_{10}(N) \quad (7)$$

For M-PSK modulation, there are only M^2 sequences having maximum PAPR equal to $10\log(N)$ as described in [9]. This means, the number of sequences that gives very high PAPR is small. If the number of sub channels increases, the ratio of the sequence (R) that gives so much PAPR and all distinct sequences decreases rapidly. The overall number of distinct sequences for the N subcarriers OFDM system with M-PSK is M^N . Thus the ratio can be obtained by:

$$R = \frac{M^2}{M^N} = M^{2-N} \quad (8)$$

From the central limit theorem, it follows that for large values of N ($N > 64$), the real and imaginary values of $x(t)$ become Gaussian distributed. Therefore the amplitude of the OFDM signal has Rayleigh distribution, with a cumulative distribution given by $F(z) = 1 - e^{-z}$. The probability that the PAPR is below some threshold level can be written as:

$$P(PAPR \leq z) = (1 - e^{-z})^N \quad (9)$$

In fact, the Complementary Cumulative Distribution Function (CCDF) of PAPR of an OFDM is usually used, and can be expressed as:

$$P(PAPR > PAPR_0) = 1 - (1 - e^{-PAPR_0})^N \quad (10)$$

This theoretical derivation is plotted against simulated values in Figure (2) for different values of sub carriers N .

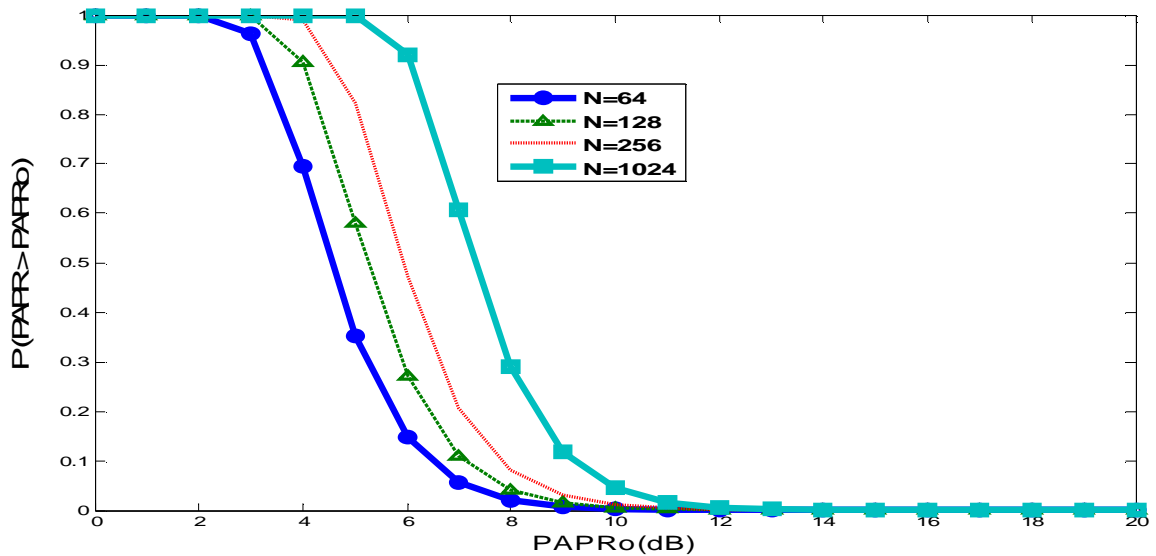
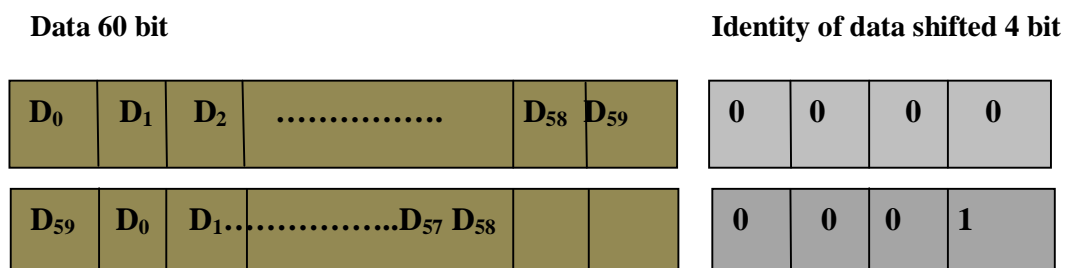

Figure (2). CCDF for different values of Sub carriers.

3. The proposed OFDM system model

The main idea in this research is to generate multiple and different patterns of the same information. Generation of these patterns leads to increasing the likelihood that the pattern which will have the least PAPR among the various patterns will be sent. A number of circular shift registers is used to generate different patterns so that each pattern is different from the other in the amount of offset in circular shift registers as shown Figure (3). Additional information that describes the amount of offset in the shift register is mixed with data. Therefore; the proposed method will not need to send the side information separately from data as in the case of SLM method. The error in the amount of shifting in the receiver side leads to an error that occurs in all the collected data, leading to increasing the BER. Hamming code method has been adopted to encrypt the amount of the offset to reduce the BER.



Figure(3). Generation of the different patterns by using circular shifters.

Figure (4) depicts the block diagram of the proposed transmitter TX-OFDM system, circular shifters are used to produce K cyclic sequences from the same information sequence where the n^{th} circular shifter shifts the sequence data by n bits ($n=0$ to $K-1$). These sequences XOR with randomly generated keys ($K=16$). Identity of Shifted Data is embedded as side information. The information (Data & Identity of Shifted Data) are modulated by using BPSK. An inverse Fourier transform converts the frequency domain information (Data & Identity of Shifted Data) set into samples of the corresponding time domain representation of this information. The sequence with the lowest PAPR, among K sequences, is chosen for the transmission. At the receiver RX-OFDM, a reverse procedure is used to demodulate the OFDM signal.

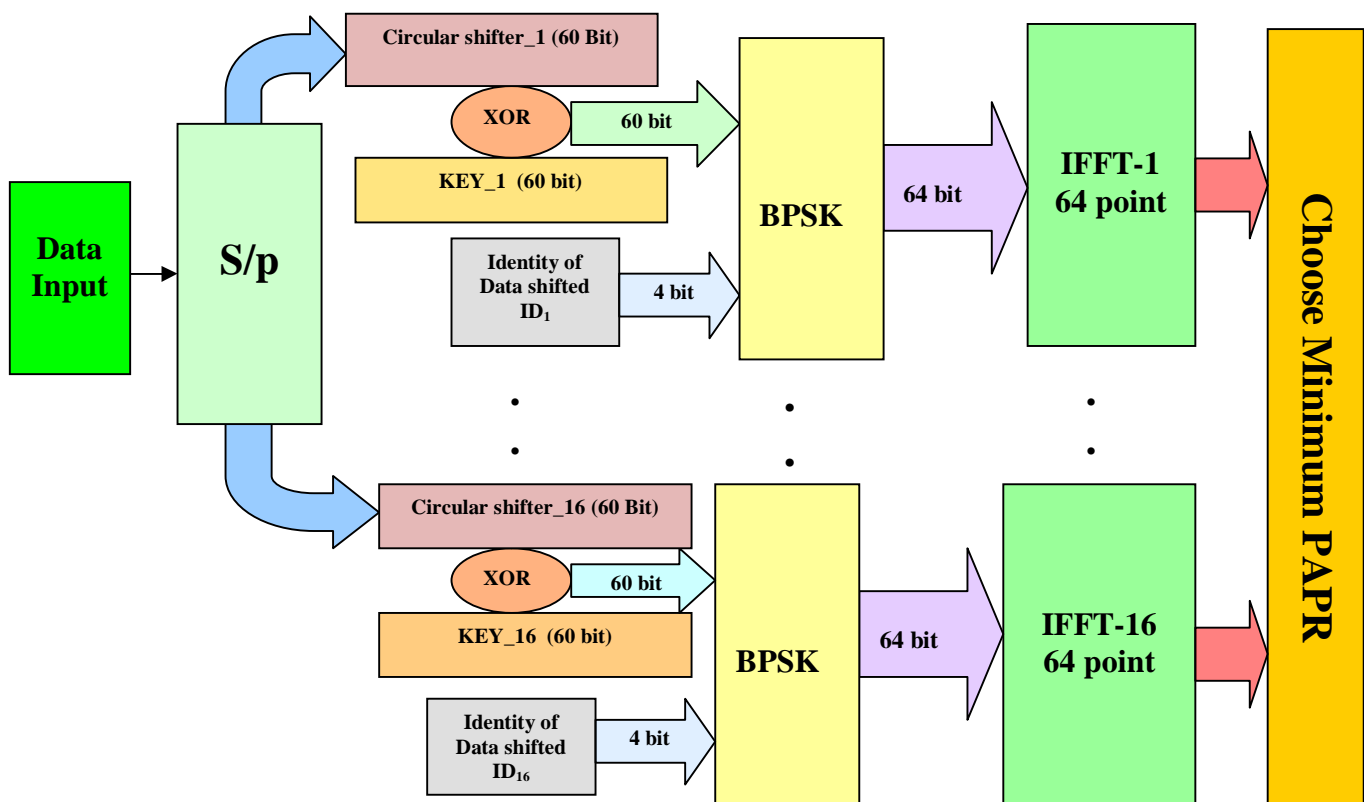

Figure (4).Block diagram of TX-OFDM proposed system.

4. Results and discussion

The proposed model of transmitter and receiver OFDM was realized in MATLAB 7.6 (R2008a) octave codes, BPSK modulated and $N=64$ sub-carriers are considered. Figure (5) shows the normalized output power of the OFDM system with and without proposed technique. From the Figure (5-a), wide variation in the instantaneous power of the conventional OFDM system which leads to large PAPR can be easily observed. Comparing with Figure (5-b), we can observe that the instantaneous power variation is reduced when we used the proposed technique.

Figure (6) depicts the (CCDF) of PAPR for the proposed OFDM system for different No. of circular shifters. The PAPR statistics improved with increasing No. of circular shifters. When No. of circular shifters are equal to 16, the PAPR can be reduced by 4-5dB as compare with the conventional OFDM system.

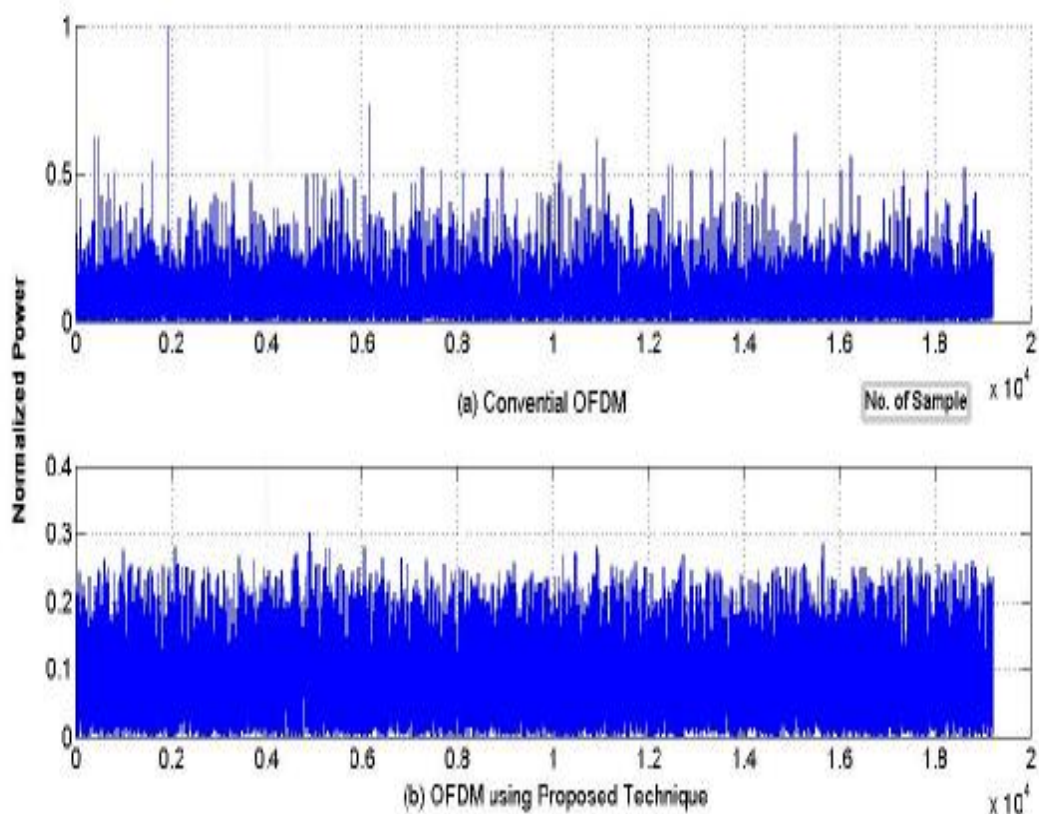

Figure (5). Normalized power of proposed OFDM system in time domain.

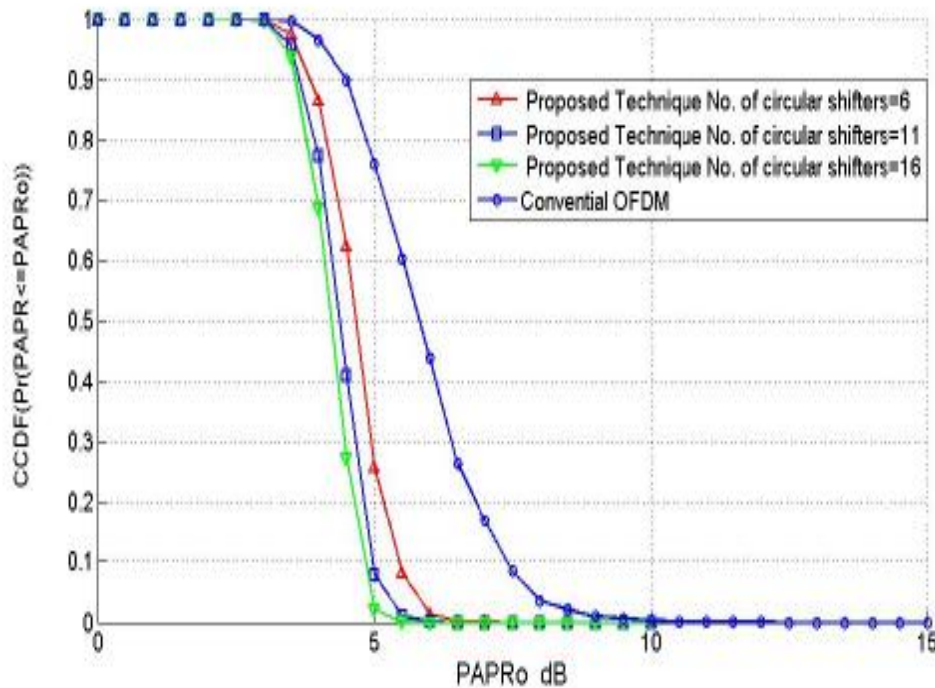

Figure (6). CCDF of papr for the proposed system.

The used Keys and XOR gates in the proposed OFDM system description in Figure (4) played a key role in obtaining a wide variation patterns for the same information and thus become to get the lowest PAPR possible.

The proposed system has been tested in the presence of noise in channel (AWGN) so as to measure the Bit Error Rate (BER). Results showed that the proposed system with K=16 circular shifters gave Bit Error Rate higher than the conventional system. The error occurs in one of the bits of Identity of Data shifted (ID) lead to crash whole the data frame which leads to increased Bit Error Rate. Error correction method is used for ID in order to reduce the error in the data frame in receiver side. Hamming code (7,4) method is used to detect the error of ID in receiver side. Results showed that the proposed coded OFDM system showed quite similar performance to the convention system, as in Figure (7).

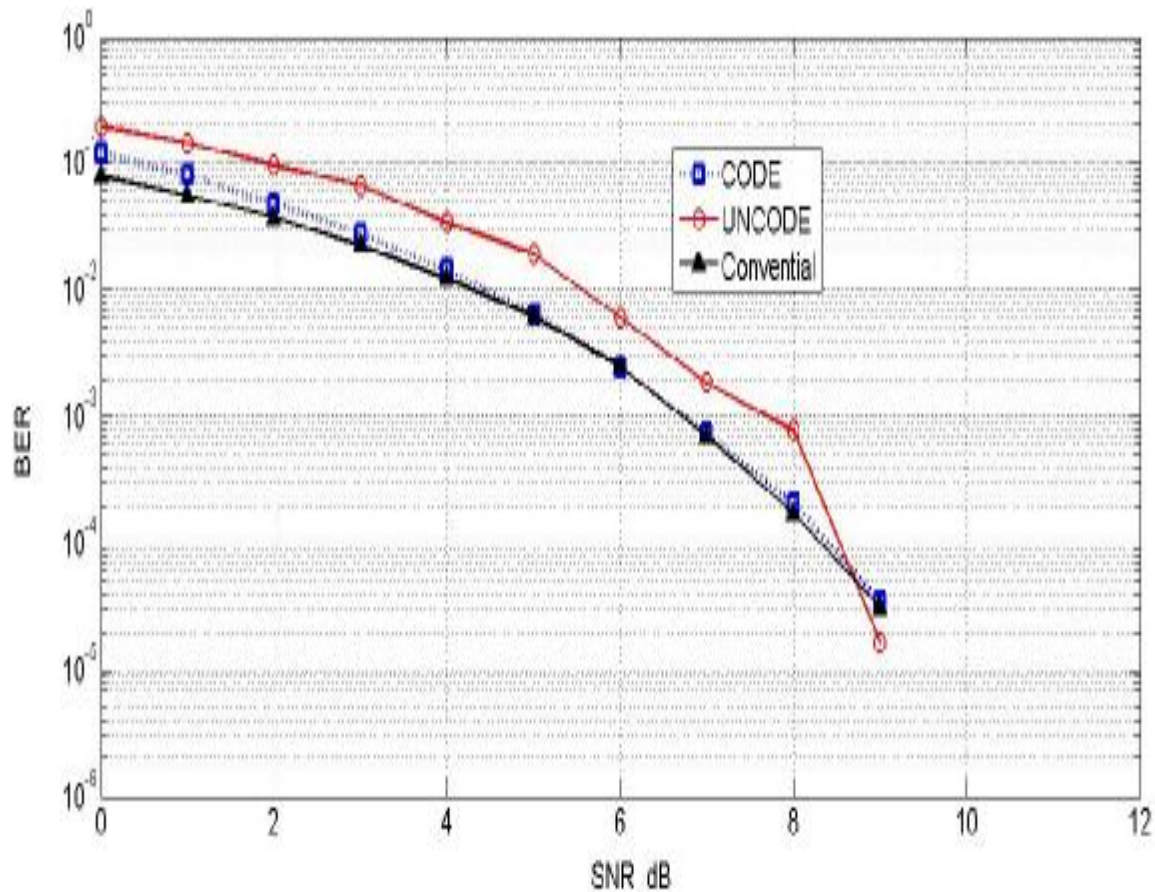

Figure (7).BER performance of the propose OFDM system.

5. Conclusions

A new Technique is proposed for the PAPR reduction in OFDM system, based on K circular shifters to shift data symbol by n^{th} bit and XOR each with K keys. Then the sequence with minimum PAPR is chosen for transmission. The proposed technique minimizes the variation in the instantaneous power of the conventional OFDM system as well as reduces PAPR. The PAPR reduction is forward proportionally to the number of circular shifter. PAPR is reduced by 4-5 dB when compared with conventional OFDM. The proposed technique offers a higher BER performance compared with conventional OFDM. The BER performance for the proposed scheme can be improved by using appropriate coding technique for ID such as Hamming code (7,4). The use of Hamming code makes the BER for the proposed OFDM system very close to that of conventional OFDM system. However, one of the difficulties in the new technique is the large number of IFFT. The proposed method is similar to SLM method, but the proposed technique doesn't require any side information as in SLM method.

6. References

- [1] Han S. H. and Lee J. H., Apr. 2005, "An overview of Peak-To-Average Power Ratio Reduction Techniques For Multicarrier Transmission", IEEE wireless Commun., vol. 12, no. 2, pp. 56-65.
- [2] Wu L.J. and Li Y.W., Aug.2007, "Reducing the PAR In OFDM Systems by Clipping Scheme". Natural Computation, 2007. ICNC 2007. Third International Conference on, vol.5, pp: 63 – 68,.
- [3] Davis J. A. , Jedwab J., 1997, "Peak-to-Mean Power Control and Error Correction for OFDM Transmission Using Golay Sequences and Reed-Muller Codes ". Electronics Letters, vol.33, no.(4),pp 267-268.
- [4] Chin-Liang W. and Yuan O. , Dec. 2005, "Low-Complexity Selected Mapping Schemes For Peak-To-Average Power Ratio Reduction In OFDM Systems" ,IEEE Transactions on Signal Processing, vol. 53, pp. 4652-4660.
- [5] Tao J. , Weidong X., Paul C. Richardson, Jinhua Guo, and Guangxi Zhu.,Sept.2007, "PAPR Reduction of OFDM Transmission Using Partial Transmit Sequences With Low Computational Complexity", IEEE Transactions on Broadcasting, vol.53, no.3,.
- [6] Dae-Woon L., Seok-Joong H., Jong-Seon N. and Habong C., March 2006, "A New PTS OFDM Scheme with Low Complexity For PAPR Reduction", IEEE Transactions on Broadcasting, vol.52, pp:77-82.
- [7] Jayalath A. D. S.,Australia2002, "OFDM for Wireless Broadband Communications (Peak Power Reduction, Spectrum and Coding)" , Phd thesis, Monash University, Clayton, VIC 3800.
- [8] Van Nee R. J., and Prasard R.,1999, "OFDM for Wireless Multimedia Communications", Artech House, Boston.
- [9] Ochiai H., March 2001, "Analysis and Reduction of Peak to Average Power Ratio in OFDM System", PhD Thesis, The Graduate School of Engineering, The university of Tokyo, Japan.